



## **FD 27 Installation Package**

### **Configurations**

1+1, 3+1, 5+1, 3+3, 7+1, 3+5, 5+5 and 5+7

**TABLE OF CONTENTS:**

Title Page.....Pg.1

Table of Contents.....Pg.1

Tools Required.....Pg.2

Elevation View Parts List.....Pg.3

Plan View Parts List.....Pg.4

Elevation View Drawing.....Pg. 5

Plan View Drawing.....Pg. 6

Installation Steps.....Pg.7

Step 1: Bottom Track.....Pg.7

Step 2: Jambs.....Pg.7

Step 3: Top Track.....Pg.8

Step 4: Rollers.....Pg.8

Step 5: Levelling Platform.....Pg.9

Step 6: Panel #1.....Pg.9

Step 7: Panel #2.....Pg.9

Step 8: Panel #3.....Pg.10

Step 9: Leveling Platform & Loading and Setting Rollers.....Pg.10

Step 10: Adjustment of Jambs.....Pg.10

Step 11: Doorstop for Swing Panel.....Pg.10

Step 12: Bi-fold Handle.....Pg.10

Step 13: HOPPE Handle.....Pg.11

Step 14: Waterproofing.....Pg.11

Operation.....Pg.12-13

## TOOLS REQUIRED

- ❖ Laser Level
- ❖ Drill
  - #1, #2, #3 Robertson Bit.
  - #2 Phillips
  - 1/8" Drill Bit
- ❖ Tape Measure
- ❖ Allen Keys
  - 2.5mm, 3mm, 5mm
- ❖ Cedar Shims
- ❖ Hammer
- ❖ Caulking
- ❖ 1x4" or 2x4" Shims

Ex.

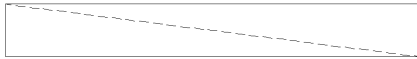

- ❖ Richards Bar (recommended)
- ❖ Knife
- ❖ Rod 1/2" (for water proofing)

### **\* If Drilling into Concrete**

- ❖ Hammer Drill
  - 5/16" Drill Bit
  - Nylon Plugs (8mm x 40mm) – 5/16" x 1 1/2"

# FD 27 SECTION VIEW PART LIST

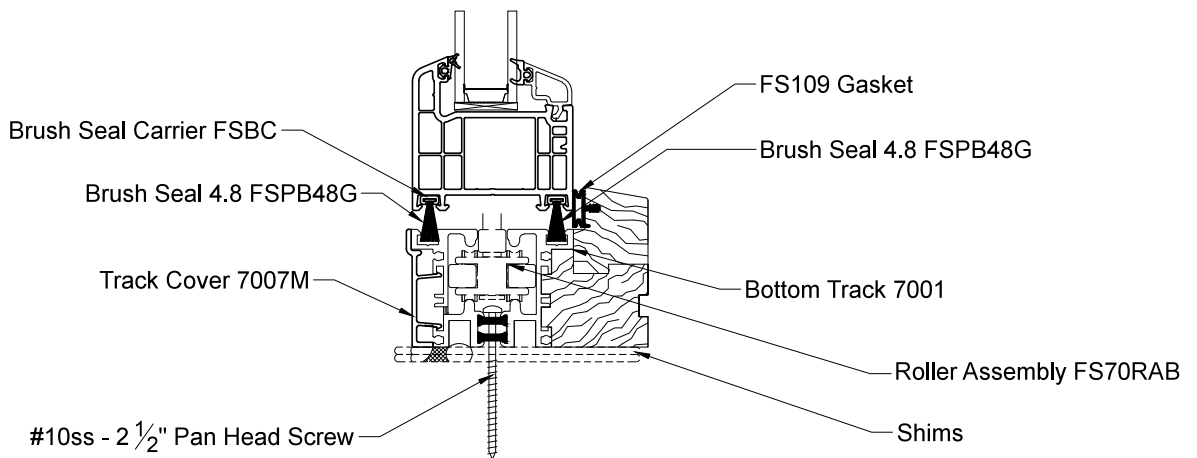
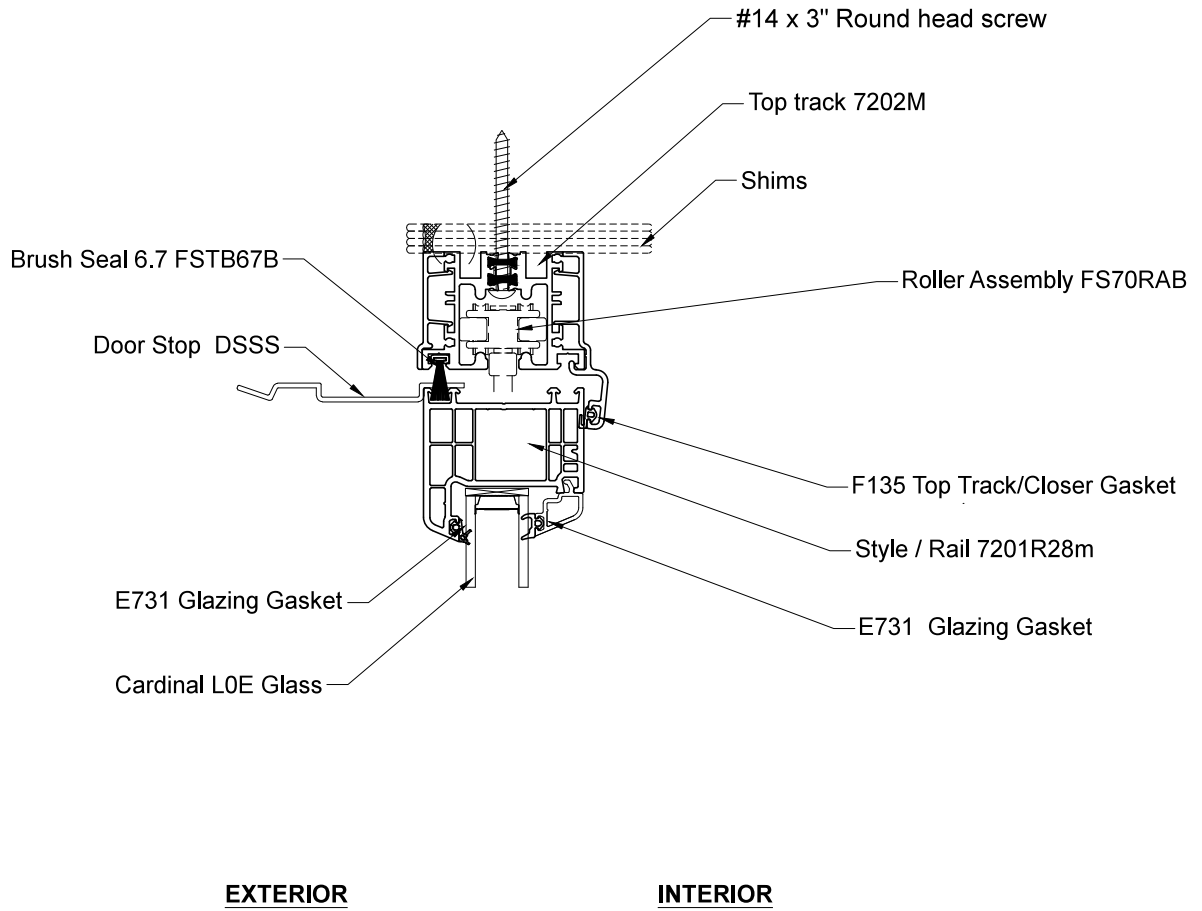

# FD 27 PLAN VIEW PART LIST

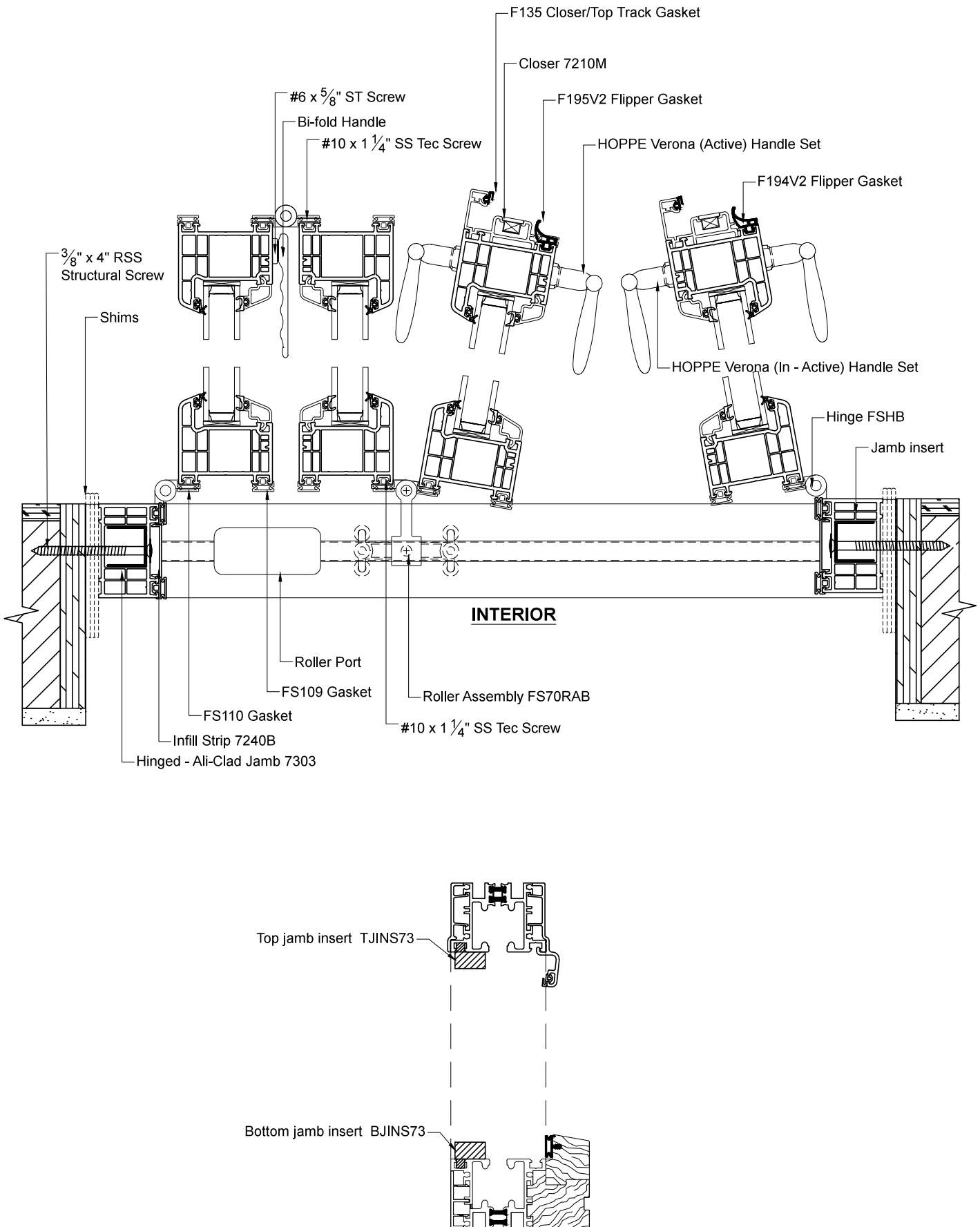

# FD 27 ELEVATION VIEW DRAWING

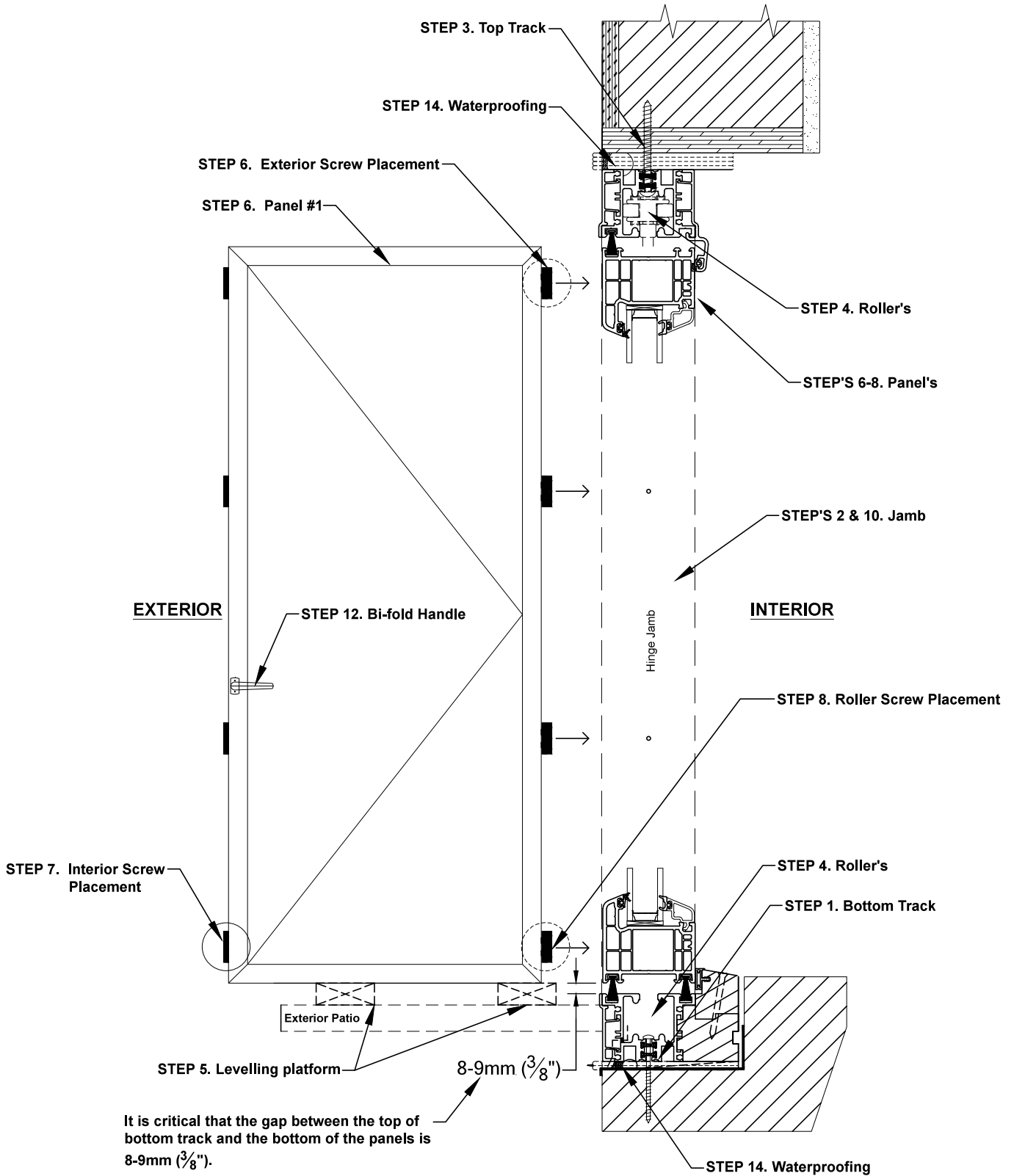

FD 27 PLAN VIEW DRAWING

CONFIGURATIONS: 1+1, 3 + 1, 3 + 3, 5+1, 5+3, 5 + 5, and 7+1

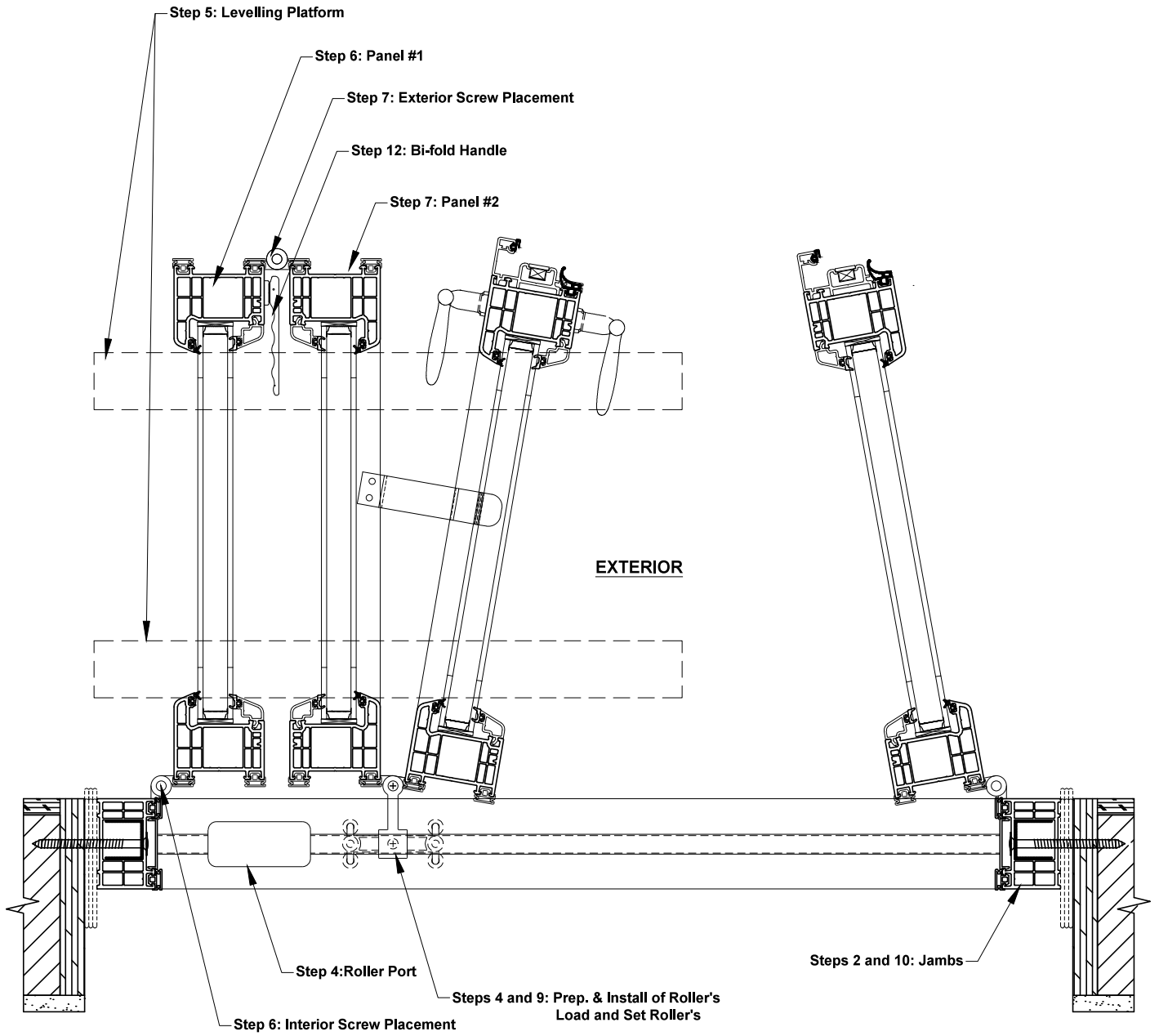

## Installation Instructions for FD27 Configurations:

**1+1, 3+1, 3+3, 5+1, 3+5, 7+1, 5+5, 7+5, 7+7, 9+7 and 9+9**

**BE SURE TO READ ALL INSTRUCTIONS PRIOR TO INSTALLING YOUR DOOR UNIT**

### Step 1. Bottom Track.

- a) Make sure the opening is made to the correct dimensions as per the sign-off drawing included as well as waterproofed to your local building code or project requirements.
- b) Place bottom track in the rebate cut out, with the oak sill to the interior and roller port to the stacking side and center it within the RO and mark where the pre-drilled holes are for shim locations.
- c) Remove the bottom track, and where you marked the pre-drilled holes; place the needed number of shims (use shims provided) so that the oak rebate will be flush with interior finished floor. Using a laser level and tape measure make sure that shims are level along the rebate in both directions.
- d) Place the bottom track in the rebate and on the shims you have now set level and to the required height. Making sure to mount the track flush to the exterior face sheeting (typical).
- e) Using screws provided (#10 x 2 1/2" SS pan head) screw both ends of the track as well as the center (**caulk/silicon screws before installing to ensure no water infiltration**), and re check to make sure that the bottom track is sitting firm and level in both directions, as well as straight once tightened down.
- f) Once you have ensured the track is level and straight proceed to put the remaining bottom track screws in.

### Step 2. Jambs.

- a) Identify the hinge jamb for stacking side and latch jamb as per figures 1 & 2.

**NOTE:** Measure jamb length from top and bottom of aluminum (do not include the protrusion of the jamb inserts) and note in the space provided in [Step 3](#).

**FD 27 HINGE JAMB LEFT**

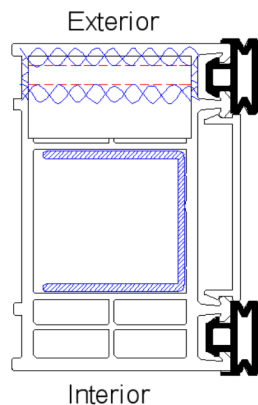

**FIG 1.**

Used for all configurations

**FD 27 HINGE JAMB RIGHT**

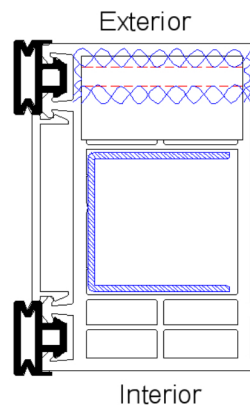
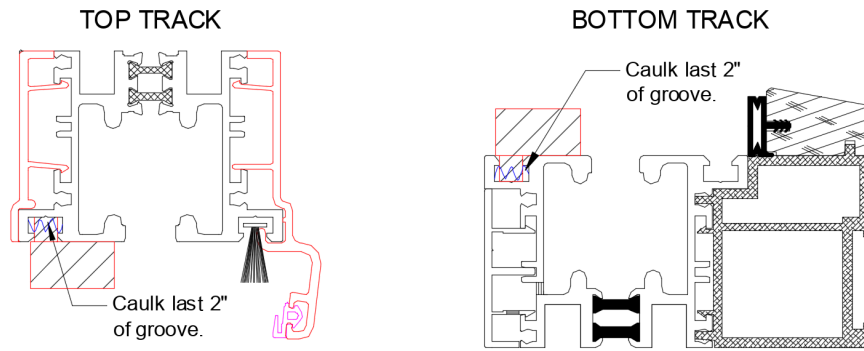

**FIG 2.**

For: 1+1, 1+3, 3+3, 3+5, 5+5, and 7+1

- b) Caulk ends of both jambs as shown in figures 1 & 2 depicted by the blue squiggly lines & remove black jamb covers.
- c) Pre screw in 2 (#10 x 4" FH screw & washer) into the **Hinge Jamb** and 2 (#10 x 4" FH Screws (no washer)) into the **Closer Jamb** in the top and bottom pre drilled locations.



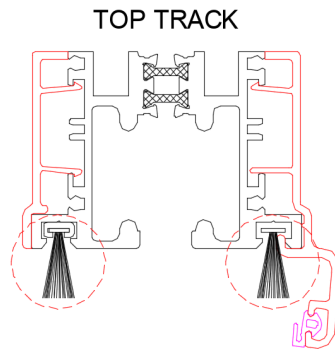

**FIG 3.**

- d) Caulk the last 2" of the outside groove & 2" from ends of track where jamb will sit to ensure no air infiltration of both top and bottom tracks before inserting jambs, as shown in FIG 3.
- e) Each jamb has an insert top and bottom to ensure panels are installed plum and square with tracks and are placed to the exterior edge. (Shown in red FIG 3.)
- f) Screw both jambs square and plum to bottom track using screws already provided in **Step 2**. Only screw in top and bottom of jambs leave the rest (middle screw locations) till **Step 10**.

### **Step 3. Top Track**

- a) Remove brush seal found in bottom track from shipping and insert into channels on the top track as shown below by red circles.



**FIG 4.**

- b) Place top track on top of jambs; make sure that the top track has clicked into the jamb inserts and is tight to top of jambs (Use cedar shims above jambs to ensure a snug fit.) prior to using screws in Step 3 (c).

❖ **Jamb length** \_\_\_\_\_

- c) First, will be to place provided break away shims and screw in the center of the top track. To do this, take the above **Jamb Length** and depending on the length of your door, add the necessary camber, see below example for camber. Using screws #14 x 3" round head screw and shims provided, screw center of track. Once that has been set, screw, and place all other top track screws and shims.

❖ Recommend having a 1/16" (1.5mm) camber per 8' of top track.

Ex. An 8' door is recommended to have a 1/16" (1.5mm) camber and from 16' up it is recommend having a 1/8" (3mm) camber. For doors over 16' use a 1/8" camber and no larger. (This is to account for minor deflection in the header.)

- d) Remove any excess caulking on the exterior face of the top and bottom jambs where they meet with the top and bottom track. (Frame has been completed until panels are installed)

#### Step 4. Rollers

- Using a 2.5mm Allen key loosen two silver setscrews on the side of all the rollers, as shown in FIG 4.
- Using a 5mm Allen key to adjust the roller 1/2" (12.5mm) for top track roller(s) and 5/8" (15.5mm) for the bottom track roller(s) using the adjustment screw, as shown in FIG 4.
- Insert all rollers into the roller port of the top and bottom tracks. **(\*It is critical to insert rollers before installation of the panels).**
- Once in, push rollers to far end of stacking side. That way when installing the panels, the top does not hit the rollers.

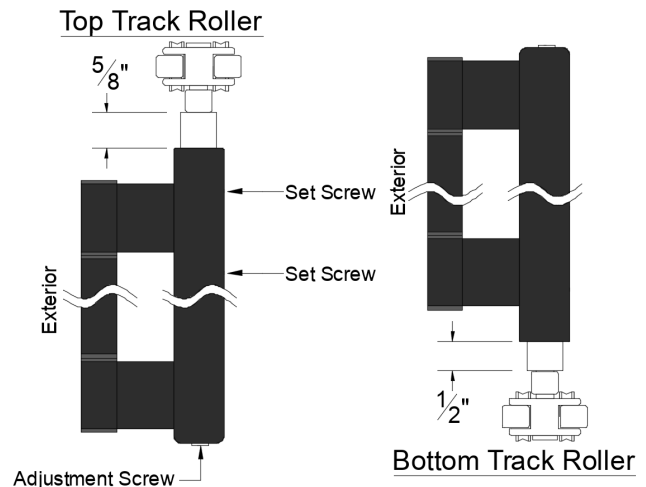
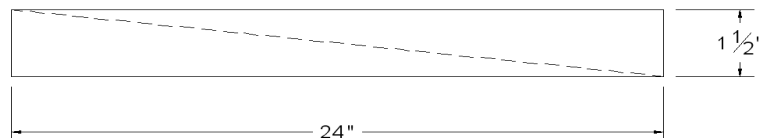

FIG 5.

#### Step 5. Levelling Platform

- Using a platform will help; level the panels, align the hinges, and support the panels for ease of installation.
- Make 2 pairs of tapered shims out of 1x4" or 2x4" depending on the clearance between the bottom of the door panels and the patio or floor system. The shims will allow you to easily adjust the levelling platform to the required height. (See [Elevation Drawing](#) on Pg. 5 for example of placement)
- Set the levelling platform to be 5/16" (8mm) above the bottom track. Ensure the platform is solid and not going to easily move. Platform should be long enough to span the thickness of all panels.



- \* It is critical to have the proper spacing of 5/16" (8mm) for the door to operate properly. (Recommend using the L key stock provided in the Dallas HOPPE handle kit.)** Using the key stock, place it on top of the bottom track, it should slide just under the bottom of the panel which ensures that it is 8mm above the top of the bottom track.

### Step 6. Installation of **panel #1**.

- a) Place panel #1 (which has a pre-installed bifold handle on it and labelled "Panel #1") feather gasket side down on the levelling platform, perpendicular to the bottom track and close enough to the jamb to align and attach the hinges that are already attached to panel #1.
- b) Attach panel to jamb using machine screws provided and shown below. Do not move the hinges that are attached to panel #1. **If the hinges do not exactly line up with the backer plates in the jamb, you can slightly move the silver backer plates and gasket up and down with in jamb to get to the required height.**

❖ Exterior/Interior hinge use 3 - #10 x 1 ¼" SS tec  
**SCREW PLACEMENT**

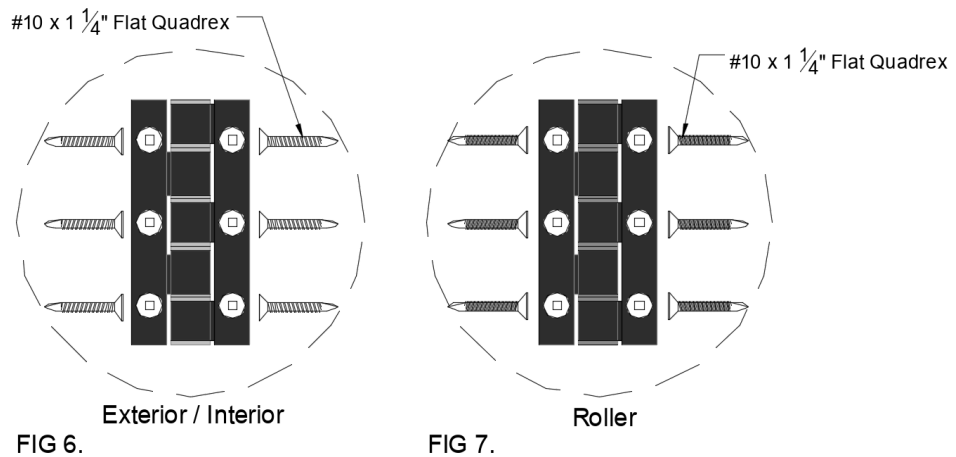

- c) Double check that panel is set to the correct height above the bottom track (**8mm / 5/16"**) as it is crucial for the installation of the following panels.

### Step 7. Installation of **panel #2**.

- a) Place panel #2 interior face - to - interior face and feather gasket side down.
- b) Using a straight edge on top (or Hoppe key stock), ensure that the panels are inline and level on the hinge side you will be screwing in place.

Attach hinges using screws provided (3 - #10 x 1 ¼" Flat Quadrex) See Fig 6.

- c) Attach the top and bottom rollers to the panel (**make sure rollers are set to the correct dimension as per FIG 5.**) using screws provided (See FIG 7.). Make sure that the roller hinges are set 5/16" (8 mm) from the bottom of the panel and 5/16" (8 mm) from the top of the panel.
- d) Attach top roller to the panel first, ensuring that the panel is level and straight with panel one. Then attach bottom roller, once both rollers have been installed screw hinges in between as per FIG 5.

### Step 8. Installation of **panel #3**.

- a) Place panel #3 exterior face – to – exterior face and feather gasket side down.
- b) Using a straight edge on top, ensure the panels are inline and level.
- c) For attaching rollers to panels repeat **Step 7:** (d) and (e)
- d) Attach the middle hinges as per FIG 5.
- e) Now the panel portion of your 3-panel unit is assembled continue to **Step 9**.
- f) For 5, 7, and 9 panel configurations repeat steps 6 thru 8 as needed.

#### **Step 9. Load and set all rollers.**

- a) To remove the leveling platform, you can use the roller assembly to lift the panels. To do this use the adjustment screw on both top and bottom rollers simultaneously. Ensuring the door panels are sitting 5/16" (8mm) above the bottom track.
- b) Adjust the bottom roller until it starts to load (feel increased resistance) at that point give it one more 1/4" turn. How smooth the panels are sliding will determine the amount of the last turn when loading the bottom roller.
- c) Test the door for smooth operation.
- d) If the door operates smoothly, remove setscrews on the rollers and use a 1/8" drill bit to make an indentation for each of the setscrews to fit back in firmly, to prevent slippage over time.

#### **Step 10. Adjusting the jambs.**

- a) Close the door all the way; this might require you to adjust the jambs to get the required 7/16" gap between the aluminum portion of the active panel closer and the aluminum portion of the closer jamb.
- b) Add or remove shims from jambs as needed, once you have the required 7/16" (11.5mm) gap put the middle shims and jamb screws in (Use screws provided #10 x 4" flat head screws & washers).
- c) Once all adjustments are complete, clip in the black plastic jamb infill's covering the screws.

#### **Step 11. Panel Catch** (Doorstop) for the swing panel.

- a) On top of the adjacent panel to the swing panel'(s), measure in 9" from the outer edge of the panel. (See Fig 10. for Example)
- b) Caulk in between the grooves on the top outer side of the panel and slide the aluminum hinge plate over the caulking before screwing down the doorstop.
- c) Place the catch over the area, and then screw down the catch tightly using screws provided (2 - #10x 1 1/4" SS Tec), be sure not to over tighten and strip the screws.

#### **Step 12. Installation of HOPPE Handle.**

- a) Please refer to installation instructions included **inside** the HOPPE handle box.

#### **Step 13. Waterproofing & RO Finishing**

- a) Rod & Caulk both top and bottom track as well as the jambs. For example, see **Elevation and Plan View Drawings** on Pg. 5-6.
- b) Be sure to waterproof & seal opening as per your local building code requirements.

**\* PLEASE NOTE \***

**IF YOU OPERATE THE DOOR OUT OF SEQUENCE**  
**YOU WILL DAMAGE THE GASKETS**

**Should you require assistance please call our office: 1-(250)-448-6418**

# HOW TO OPERATE YOUR ACTIVE/INACTIVE DOOR

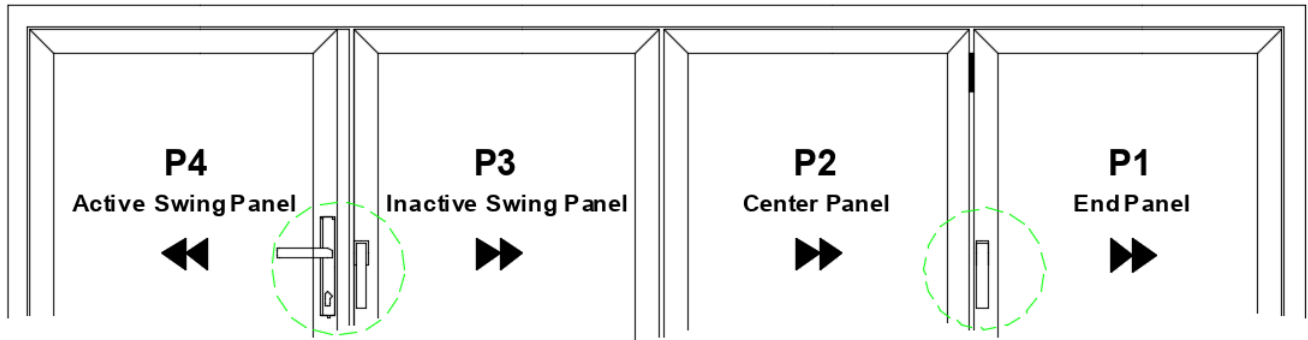

1. Starting from main swing panel, OPERATE lever handle then outward open MAIN SWING PANEL inline with adjacent center panel, allowing it to clip in to stop.
2. Release Bi-Fold handle(s) then PUSH center panel adjacent to end panel.
3. Fold all panels back against the wall for maximum opening.

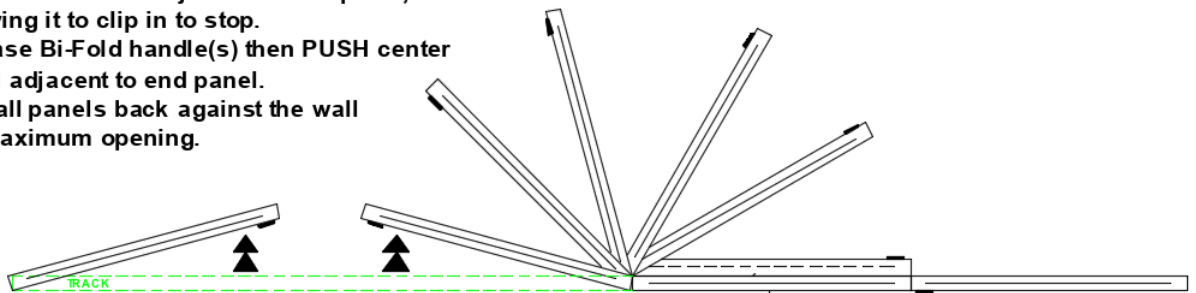

Stage 1: (Inside View)  
Swing door opens first  
Fold Fully back in-line

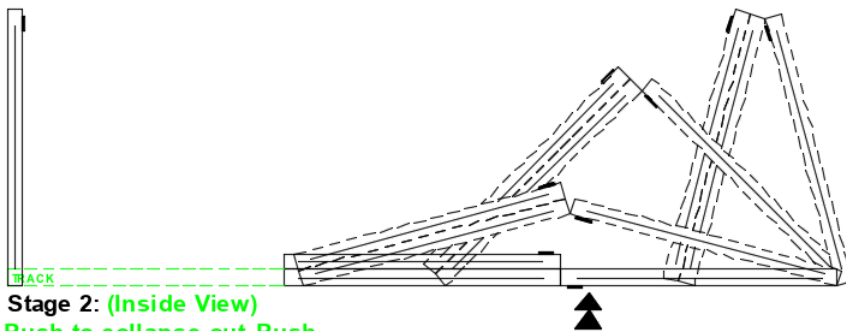

Stage 2: (Inside View)  
Push to collapse out, Push  
from Roller side to control door

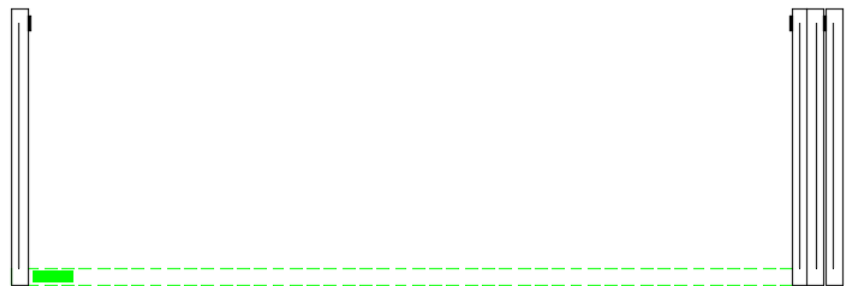

Stage 3: (Inside View) Fully open position

# HOW TO CLOSE YOUR ACTIVE DOOR

1. Hold panels 2 & 3 and walk in the direction of the track
2. The rollers are utilized giving a smooth closure to the Bi-Fold door.
3. Close and secure the end swing panel

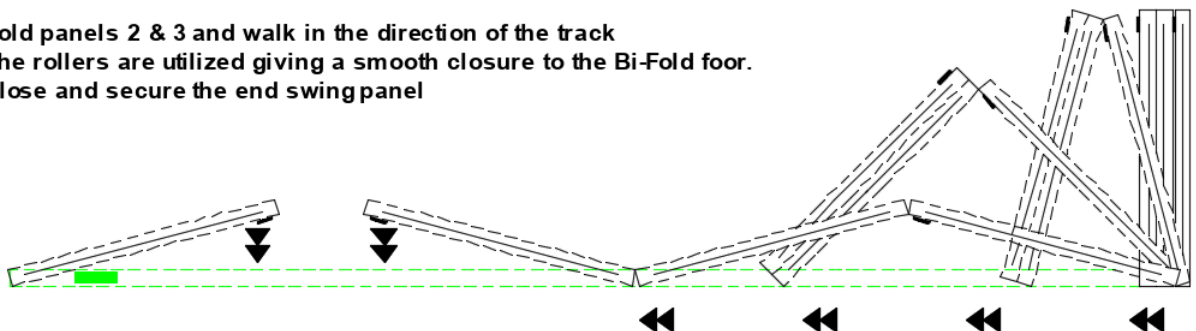

# HOW TO OPERATE YOUR ACTIVE/INACTIVE DOOR

(RIGHT HAND STACKING / OUTWARD OPENING)

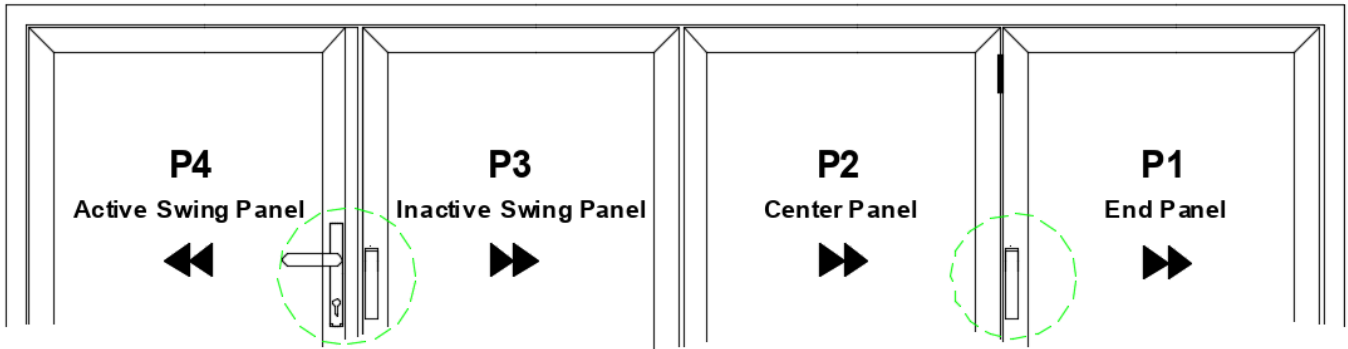

## HOW TO OPERATE YOUR LEVER HANDLE

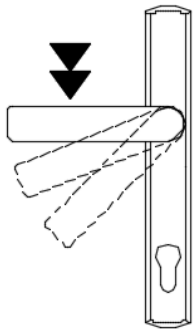

1.) To Open (Main Swing):  
Push handle down at 45°, and push open. (Allow panel to click into panel catch on the adjacent panel.)

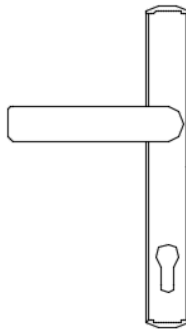

2.) To Close door pull panel shut to Latch like a typical entry way door.

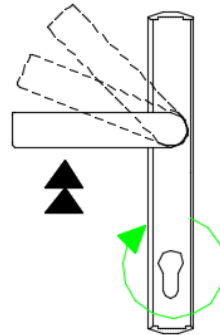

3.) After latching pull handle Up at 45°, well pulling In. Then engage lock with thumb turn 90° clockwise.

## HOW TO OPERATE YOUR BI-FOLD HANDLE



1.) Bi-fold handle in locked position. (When door is closed)

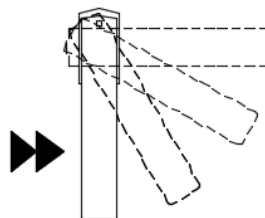

2.) To Open bi-fold, pull handle up 90° and release then push out.

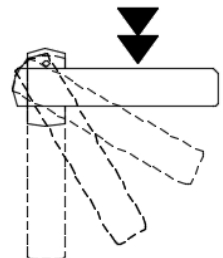

3.) To Close bi-fold, in one motion push handle down 90°.